

# CAESAR

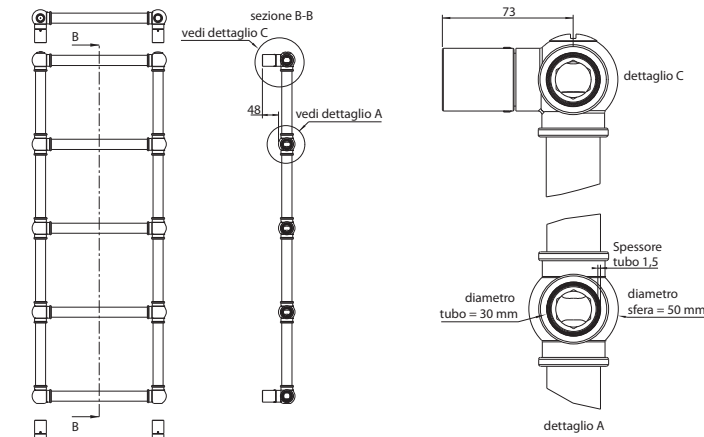

Valvole v. pag. 138.  
 Valves see pag. 138.  
 Vannes voir pag. 138.  
 Ventile siehe Seite 138.  
 Válvulas ver pág. 138.  
 Клапана см. на с. 138.

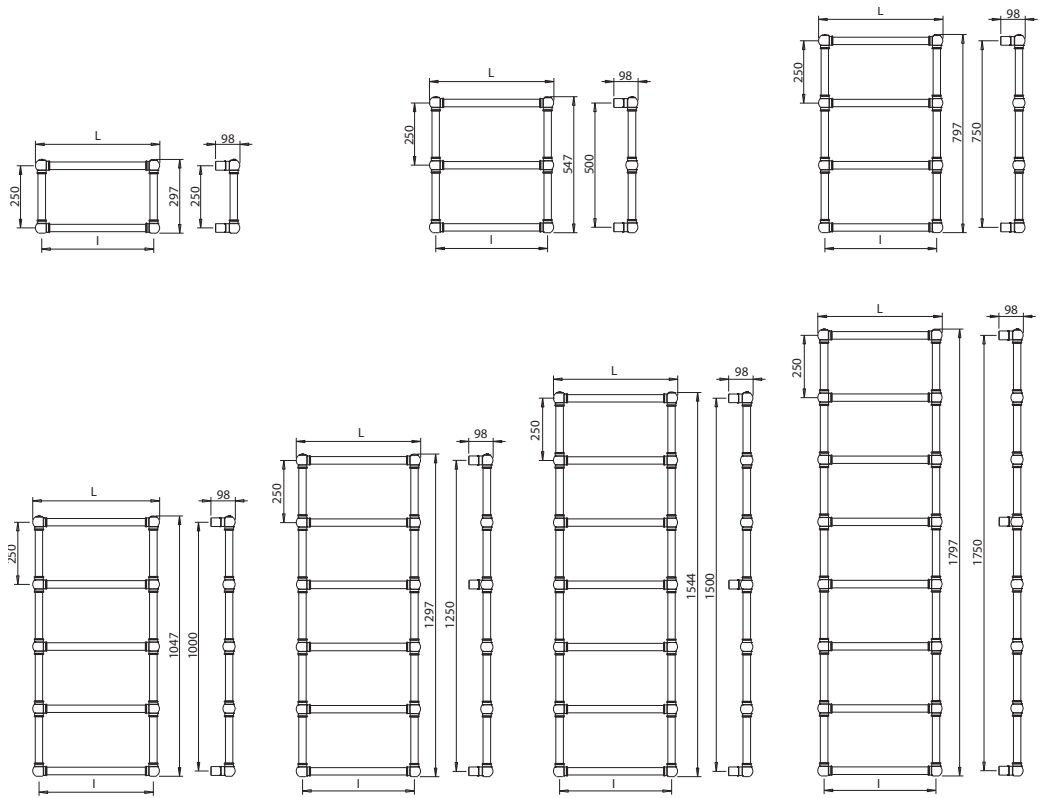
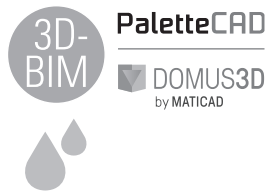

cromato  
 chromed  
 chrome  
 verchromt  
 cromado  
 хромированный



oro  
 gold  
 or  
 Gold  
 oro  
 золото



bronzo  
 bronze  
 bronze  
 Bronze  
 bronze  
 бронза



rame  
 copper  
 cuivré  
 Kupfer  
 cobrizo  
 медь



argento satinato  
 satined silver  
 argent satiné  
 Silber satiniert  
 plata satinado  
 серебро атласа



grigio titanio  
 grey titanium  
 gris titane  
 Grau titan  
 gris titanio  
 титаново-серый

## APPENDIABITO CAESAR

towel hanger / pateres / Badmantelaufhänger / colgador / вешалка для одежды



colori . colours . couleurs . Farben . colores . цвета					
cromo chrome chromé verchromt cromada хромированный	oro gold or Gold oro золото	bronzo bronze bronze Bronze bronze бронза	rame copper cuivré Kupfer cobrizo медь	argento satinato satined silver argent satiné Silber satiniert plata satinado серебро атласа	grigio titanio grey titanium gris titane Grau titan gris titanio титаново-серый
101088CR	101088G	101088BR	101088RA	101088AS	101088NT

Può essere applicata **solo** da Caleido in fase di assemblaggio. In fase d'ordine precisarne la posizione.

It can be mounted **only** by Caleido during assembly. Specify the position when ordering.

Il peut être appliqué **seulement** par Caleido pendant montage. Spécifier la position dans la commande.

Die Montage kann nicht nachträglich erfolgen und ist **nur** ab Werk möglich. Bei der Bestellung die Position angeben.

Puede ser instalada **unicamente** por la empresa Caleido durante la preparación del radiador. En el pedido especificar la posición.

Он может быть применен **только** Caleido будучи сборка. Уточняйте позиции при оформлении заказа

Watt = Kcal/h ÷ 0,860  
Kcal/h = Watt × 0,860

codice code Artikel Nr. codigo код	n° elementi n° of elements no. des éléments Anzahl der Elemente no. elementos кол-во секций	altezza height hauteur Höhe altura Высота	larghezza width largeur Breite ancha ширина	interasse distance between bars entraxe Achsabstand distancia entre centros межцентровое расстояние	output - verniciato output - painted output - peint Output - lackiert output - pintado мощность - окрашенный
		H mm	L mm	I mm	75/65-20  watt/kcal/h Δt50
CAE02400...	2	297	400	350	77
CAE02500...	2	297	500	450	96
CAE02600...	2	297	600	550	115
CAE03400...	3	547	400	350	116
CAE03500...	3	547	500	450	145
CAE03600...	3	547	600	550	174
CAE04400...	4	797	400	350	155
CAE04500...	4	797	500	450	194
CAE04600...	4	797	600	550	231
CAE05400...	5	1047	400	350	194
CAE05500...	5	1047	500	450	243
CAE05600...	5	1047	600	550	288
CAE06400...	6	1297	400	350	232
CAE06500...	6	1297	500	450	291
CAE06600...	6	1297	600	550	345
CAE07400...	7	1547	400	350	272
CAE07500...	7	1547	500	450	338
CAE07600...	7	1547	600	550	404
CAE08400...	8	1797	400	350	311
CAE08500...	8	1797	500	450	388
CAE08600...	8	1797	600	550	458

**Scaldasalviette componibile in tubo di ottone.**  
Pressione di esercizio: 4 bar

**Sectional brass tubed towel rail.**  
Working pressure: 4 bar

**Sèche-serviettes modulaire en laiton.**  
Pression d'exercice: 4 bars





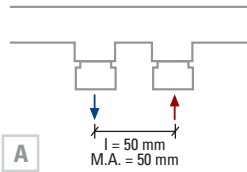

**Aus Messing montierbare Handtuchwärmer.**  
Betriebsdruck: 4 bar

**Calientatoallas modulare en tubo de latón.**  
Presión de trabajo: 4 bar



**Полотенцесушитель модульный латунная трубка.**  
Рабочее давление – 4 бар  
Под заказ радиаторы могут проходить испытание при 16 бар в случае рабочего давления 12 бар.



Il modello Caesar è disponibile, **a richiesta**, con interasse 50 mm.  
Caesar is available, **on request**, with a distance between centers of 50 mm.  
Le modèle Caesar est disponible **sur demande** avec un entraxe de 50 mm.  
Der Heizkörper Caesar ist, **auf Anfrage**, mit Mittelanschluss 50mm verfügbar.  
El modelo Caesar está disponible, **bajo pedido**, con una distancia entre centros de 50 mm.  
Модель Caesar имеется, **под заказ**, с межосевым расстоянием 50 мм.  
p./S. 362

 cod. <b>101076CR</b>	 cod. <b>101076G</b>	 cod. <b>101076BR</b>	 cod. <b>101076RA</b>	 cod. <b>101076AS</b>	 cod. <b>101076NT</b>
cromato . chromed . chrome . verchromt . cromado . хромированный	oro . gold . or . Gold . oro . золото	bronzo . bronze . bronze . Bronze . bronce . бронза	rame . copper . cuivré . Kupfer . cobrizo . медь	argento satinato . satined silver . argent satiné . Silber satiniert . plata satinado . серебро атласа	grigio titanio . grey titanium . gris titane . Grau titan . gris titanio титаново-серый

p./S. 395

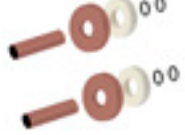
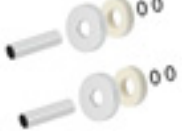
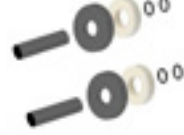
 cod. <b>101094CR</b>	 cod. <b>101094G</b>	 cod. <b>101094BR</b>	 cod. <b>101094RA</b>	 cod. <b>101094CRS</b>	 cod. <b>101094NT</b>
---	--	---	--	--	---

p./S. 400



Raccordi per valvole 24 x 19 . Fittings for valves 24 x 19 . Raccords pour vannes 24 x 19 .  
Klemmverschraubungen 24 x 19 , racores para válvulas 24 x 19 . Муфты 24 x 19  
p./S. 399

caleido